

6 RISER PRECAST PLATFORM STEP UNIT

WIDTH OF "A"	APPROX. WEIGHT
48"	2825 LBS
60"	3290 LBS
72"	3750 LBS

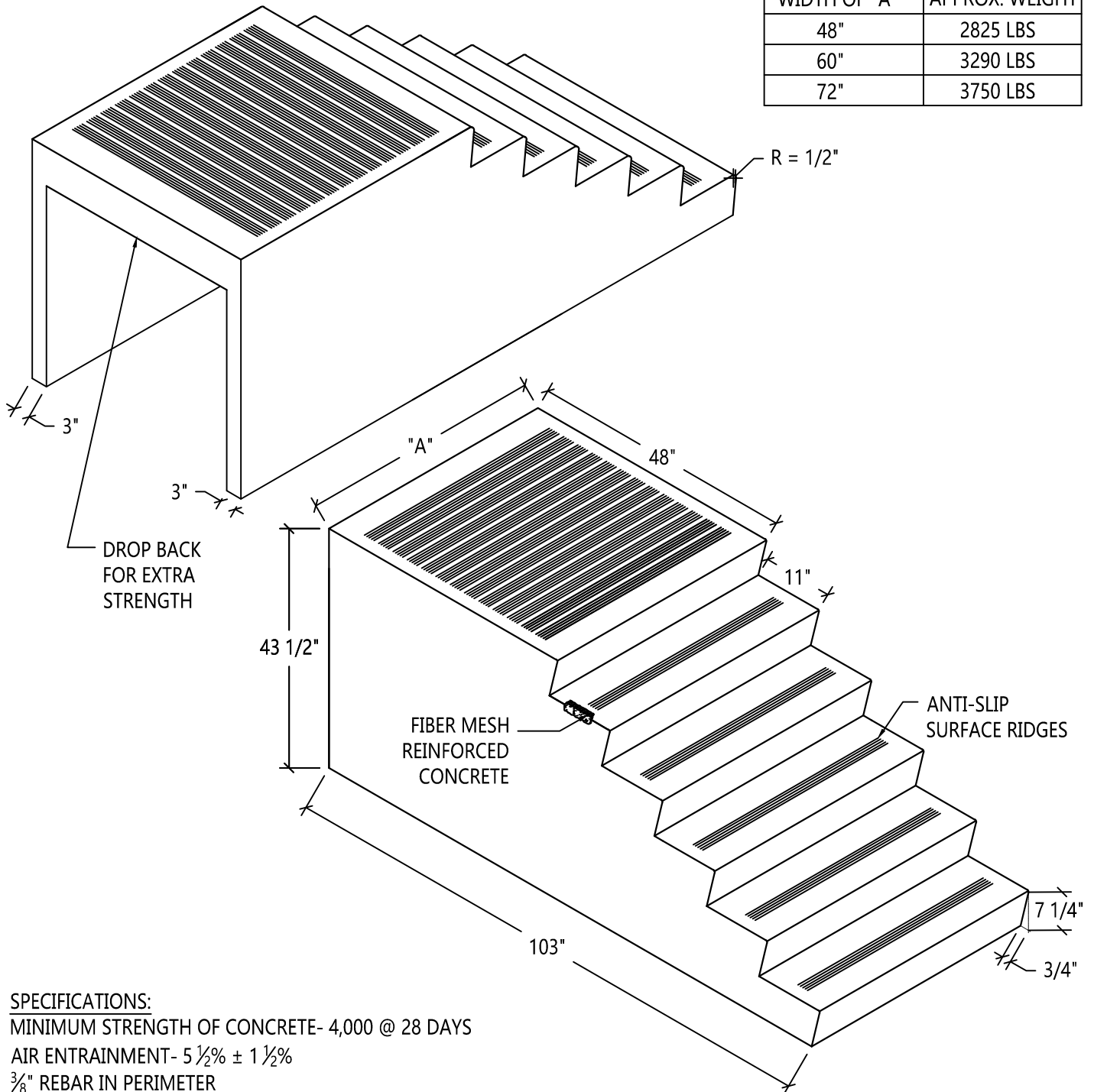

SPECIFICATIONS:
 MINIMUM STRENGTH OF CONCRETE- 4,000 @ 28 DAYS
 AIR ENTRAINMENT- 5 1/2% ± 1 1/2%
 3/8" REBAR IN PERIMETER



Scranton Craftsmen, Inc



930 Dunmore Street

Throop, PA 18512

www.scrantoncraftsmen.com

sales@scrantoncraftsmen.com

Toll Free: 1800-775-1479

Phone: (570) 347-5125

Fax: (570) 489-4212